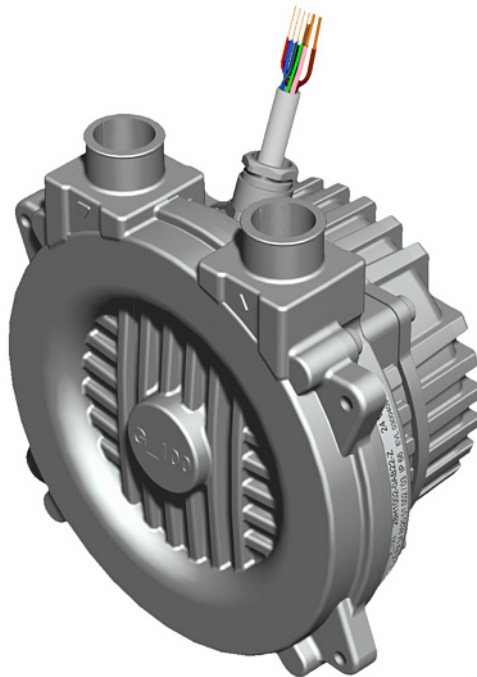


# Gas-Ring Vacuum Pumps/ -Compressors    Operating Instructions

## G-Series

Types    2BH10 02-    2BH10 02-    2BH10 02-  
              \_AB32       \_AB22       \_AA53



© Gardner Denver Deutschland GmbH 2007



















Replication, distribution and / or editing of this document and the use and distribution of its content is prohibited unless explicitly permitted. Violation obligates compensation for damages.  
All rights reserved in case of the issue of a patent, utility patent or design patent.




**Gardner**  
**Denver**


# 1 Table of Contents

1	Table of Contents .....	3
2	Safety and Residual Risks.....	4
3	Intended Use .....	6
4	Technical Data.....	7
4.1	Nominal and Limiting Values Pump .....	7
4.2	Nominal and Limiting Values Motor and Electronics .....	8
5	Transport and Handling.....	12
6	Installation and Commissioning.....	12
6.1	Mounting .....	12
6.2	Connection .....	14
6.2.1	Electrical Connection (Motor).....	14
6.2.1.1	G_100 for external electronics.....	15
6.2.1.2	G_100 with <u>integrated</u> electronics .....	20
6.2.2	Pipe / hose connections (pump) .....	22
6.3	Commissioning.....	24
7	Operation .....	25
8	Servicing .....	26
8.1	Maintenance.....	27
8.1.1	Cleaning .....	27
8.1.2	Inspection.....	28
8.1.3	Lubrication.....	28
8.2	Repair / Troubleshooting.....	28
9	Shutting Down and Measures for Prolonged Standstill .....	30
10	Manufacturer's Declaration / Declaration of Conformity .....	31



## 2 Safety and Residual Risks

	<p>Before beginning to work on the G_100 or the system carry out the following steps for both the G_100 and the entire system</p> <ul style="list-style-type: none"> <li>- switch off electricity,</li> <li>- lock against restart,</li> <li>- ensure absence of electricity,</li> <li>- ground and short-circuit installation,</li> <li>- cover or bar adjacent live parts,</li> <li>- depressurise both pipes and pump.</li> </ul>		<p>Operation of the G_100 only with the pipes / hoses connected to the suction and delivery branches!</p> <p><b>WARNING!</b> In case of operation with open suction or delivery branches (drawing-in of gases from or discharge of gases into the surroundings) a piece of pipe or hose <b>with a length of at least 120 mm must by all means</b> be connected to the branch in question in order to prevent the impeller from being reached by fingers!</p> <p>Disassembly of the pipes / hoses connected to the suction and delivery branches only after the impeller has come to a complete standstill! Consider impeller run-out!</p>
	<p>Do not wear long, loose hair! Use a hair net! Never wear wide, loose clothes!</p>		<p>Do not reach into the G_100 through open suction or delivery branches! Do not insert any objects into the G_100 through the openings!</p>
	<p>Transport and handling as well as assembly and disassembly may be carried out by trained and responsible personnel only!</p>		<p>Operation of the G_100 only with the motor cap assembled! Disassembly of the motor cap is prohibited.</p>
	<p>Operation of the G_100 only</p> <ul style="list-style-type: none"> <li>- with the gases as indicated in section 3, "Intended Use"!</li> <li>- with the values as indicated in section 4, "Technical Data"!</li> </ul>		<p>For protection against the running rotor provide a guard in front of the motor!</p>
	<p>Check pipes/hoses and vessels for sufficient strength!</p>		<p>Operation of the G_100 only with the guard in front of the motor assembled!</p>
	<p>Check pipe / hose connections for tightness!</p>		<p>Disassembly of the guard in front of the motor only after the rotor has come to a complete standstill! Consider rotor run-out!</p>
	<p>Operation of the G_100 only when completely assembled and securely fastened to the mounting surface!</p>		<p>Work on electrical installations may be carried out by trained and authorised electricians only!</p>
	<p>Check fasteners for secure fixing at regular intervals!</p>		<p>The electrical connections must be surrounded by a housing which is proof against foreign bodies, humidity, etc.! Consider the life expectancy of the seals and gaskets!</p>
	<p>After loosening clampings and fastening elements some parts and components are only held in place by their centrings or seatings or are no longer held in place at all so that they might fall down. Take the necessary care during disassembly and assembly!</p>		<p>Ensure that no foreign bodies, humidity, etc. enter the motor interior!</p>
	<p>Operation of the G_100 only with the pump lid assembled!</p> <p>Disassembly of the pump lid only after the impeller has come to a complete standstill! Consider impeller run-out!</p>		

	<p>For heat dissipation and cooling provide a <b>minimum distance of 15 mm</b> on each side except for the pump lid side on which a smaller distance of <b>at least 2 mm</b> is permissible!</p>
	<p>Burning and scalding hazard due to hot surfaces of the G_100! Do not touch during operation! Let the unit cool after shut-down! Provide a guard against accidental contact!</p>
	<p>The motor of the G_100 including its connecting leads must be protected against electrostatic discharge (ESD). Do not remove the ESD-prevention bag surrounding the lead ends until right before carrying out the electrical connection (attaching the connector, connecting to a terminal strip, or the like)! Carry out the electrical connection using the appropriate ESD-prevention equipment!</p>

	<p><b>Danger zone:</b> The vicinity of the unit during operation with open suction or delivery branches (drawing-in of gases from or discharge of gases into the surroundings) <b>Hazard:</b></p> <ul style="list-style-type: none"> <li>• Injuries due to contact with pressurised fluids or due to sudden acceleration of parts.</li> <li>• Injuries due to parts thrown out of the unit.</li> </ul> <p><b>Protective measures:</b></p> <ul style="list-style-type: none"> <li>• Ensure that fluids discharged into the surroundings are not expelled close to people (e.g. work stations on machines)!</li> <li>• During work on or near the unit wear personal protective equipment!</li> </ul>
---	---

**Residual Risks**

	<p><b>Danger zone:</b> Hot surface. <b>Hazard:</b> Burning / scalding hazard. <b>Protective measures:</b> Attach warning sign "Warning of hot surface".</p>
	<p><b>Danger zone:</b> Impeller of the pump can be reached through open suction or delivery branches. <b>Hazard:</b></p> <ul style="list-style-type: none"> <li>• Severing of limbs.</li> <li>• Drawing-in and entanglement of hair.</li> </ul> <p><b>Protective measures:</b></p> <ul style="list-style-type: none"> <li>• Operation only with the pipes / hoses connected to the suction and delivery branches! In case of operation with open suction or delivery branches (drawing-in of gases from or discharge of gases into the surroundings) a piece of pipe or hose <b>with a length of at least 120 mm</b> must <b>by all means</b> be connected to the branch in question!</li> <li>• Use a hair net!</li> </ul>

### 3 Intended Use

These operating instructions

- must be completely read and understood by all operating and servicing personnel before beginning to work with or on the G\_100,
- must be strictly observed,
- must be available at the site of operation of the G\_100,
- applies to Gas-Ring Vacuum Pumps / Compressors, type G\_100,
- contains instructions bearing on transport and handling, installation, commissioning, operation, servicing, shut-down, and storage of the G\_100.

The operating and servicing personnel working with or on the G\_100:

- must be trained and authorised for the work to be carried out.
- Work on electrical installations may be carried out by trained and authorised electricians only.

The G\_100

- are single-stage gas-ring vacuum pumps / compressors
- are machines used to generate vacuum or overpressure
- are used to extract, to deliver and to compress the following **pumped gases**:
  - air
  - other gases, which are not explosive, flammable, aggressive, or toxic
  - The pumped gases must not contain any solid bodies or impurities; those must be separated before entering the unit by means of a filter.
- exist in four fundamental designs<sup>1</sup>:
  - 2BH10 02-0AB32: hose connection with enclosed motor and integrated electronics
  - 2BH10 02-0AB22: hose connection with enclosed motor and integrated electronics
  - 2BH10 02-0AA53: hose connection with enclosed motor external electronics
  - 2BH1002-1....: flange connection

- are intended for industrial applications
- are designed for continuous operation; in case of increased turn-on frequency or increased intake and ambient temperature the limiting overtemperature of the winding and the bearings must not be exceeded (operation only according to Fig. 3, "Permissible total differential pressure / conversion factor", p. 11).

When operating the G\_100 it is imperative to observe the limiting values given in section 4, "Technical Data".

#### Foreseeable Misuse



It is prohibited

- to use the G\_100 in applications other than industrial applications,
- to use the G\_100 in areas where explosive atmosphere might occur,
- to extract, to deliver and to compress explosive, flammable, aggressive or toxic fluids,
- to operate the G\_100 with values other than those given in section 4, "Technical Data".

Any unauthorised modifications of the G\_100 are prohibited for safety reasons.

Maintenance work is only allowed to the extent described in these operating instructions.

Any further maintenance work as well as repair work may only be carried out by companies authorised by the manufacturer (please contact your sales engineer).

	<p><b>IMPORTANT!</b> The G_100 is a component intended to be incorporated in a machine or system. It is delivered for this purpose to manufacturers of such machinery or systems (OEMs) only.</p>
	<p><b>IMPORTANT!</b> The installation of the G_100 in your machine or system must be carried out in keeping with the requirements on electromagnetic compatibility according to the EMC Directive.</p>

<sup>1</sup> In order to determine the design of your G\_100 refer to the type number (MLFB) on the rating plate.

## 4 Technical Data

### 4.1 Nominal and Limiting Values Pump

Type (MLFB)	2BH10 02-_AB32 (with enclosed motor and integrated electronics)	2BH10 02-_AB22 (with enclosed motor, integrated electronics)	2BH10 02-_AA53 (with enclosed motor, external electronics)
Weight	1,2 kg	1,2 kg	1,5 kg
Dimensions	see Fig. 1 & 2 / p. 9/10	see Fig. 1 & 2 / p. 9/10	see Fig. 1 & 2 / p. 9/10
Sound level <sup>2</sup>	48 dB(A)	51 dB(A)	55 dB(A)
max. permissible total differential pressure <sup>3</sup> at +15°C			
• vacuum pump operation <sup>4</sup>	100 mbar	105 mbar	185 mbar
• compressor operation <sup>5</sup>	105 mbar	105 mbar	190 mbar
max. permissible differential pressure between pump interior and surroundings	0.15 bar	0.11 bar	0.15 bar
max. permissible intake and ambient temperature	+ 40°C	+ 40°C	+ 40°C
max. permissible speed <sup>6</sup>	9,500 min <sup>-1</sup>	12,000 min <sup>-1</sup>	15,000 min <sup>-1</sup>
bearing life L10 <sup>7</sup>	20,000 h	20,000 h	20,000 h
electrical data	see section 4.2, "Nominal and Limiting Values Motor and Electronics", p. 8, and section 6.2.1, "Electrical Connection (Motor)", p. 14		

Max. permissible dynamic load of the G\_100 due to vibrations from outside:

Vibration frequency	Vibration value	
< 6.3 Hz	Vibration displacement	$s \leq 0.16 \text{ mm}$
6.3 Hz ... 63 Hz	Vibration velocity	$v_{\text{rms}} \leq 4.5 \text{ mm/s}$
> 63 Hz	Vibration acceleration	$a \leq 2.55 \text{ m/s}^2$

<sup>2</sup> Surface sound pressure level (DIN 45 635, Part 13), measured at a distance of 1 m at an operating point of approx.  $\frac{2}{3}$  of the permissible total differential pressure with the pipes / hoses connected and without vacuum or pressure limiting valve.

<sup>3</sup> Permitted only with:  
unobstructed cooling,  
an operating voltage of 24 V,  
a speed reference value of 10 V and  
left-handed rotation of the G\_100.

The indicated **temperature** refers to the gas intake temperature. It is assumed that the gas intake temperature equals the ambient temperature of the G\_100.

**IMPORTANT:** For the max. permissible total differential pressure at temperatures other than +15°C see Fig. 3, "Permissible total differential pressure / conversion factor", p. 11.

In case of **increased throttling** inside the suction or delivery pipe a pressure relief valve must be provided. In case of **reduced speeds** by means of a lower speed reference value the max. permissible total differential pressures change as well.

<sup>4</sup> Vacuum pump operation: extraction of air  
having the indicated temperature at the suction branch  
and a pressure of 1013 mbar at the delivery branch.

<sup>5</sup> Compressor operation: compression of air  
having the indicated temperature at the suction branch  
and a pressure of 1013 mbar at the suction branch.

<sup>6</sup> Max. permissible speed due to the mechanical components and the design of the unit..

<sup>7</sup> For:  
operation within the permissible operating range,  
the max. permissible dynamic load due to vibrations from outside and  
fastening by means of **rubber / metal elements** (available as accessories).

## 4.2 Nominal and Limiting Values Motor and Electronics

### G\_100 with integrated electronics

<b>Type 2BH10 02- _AB32</b>		
<b>Quantity</b>	<b>Value</b>	<b>Unit</b>
Voltage range	14...28	V DC
Nominal voltage	24	V DC
Max. input current	4,5	A
Nominal speed	9500	min <sup>-1</sup>
Motor rating	90	W
Speed control range	1000 - 9500	min <sup>-1</sup>
Internal resistance at desired speed	70	Ω
Permissible ambient temperature	-10 ... +40	°C
Relative humidity	max. 95	%

<b>Type 2BH10 02- _AB22</b>		
<b>Quantity</b>	<b>Value</b>	<b>Unit</b>
Voltage range	14...28	V DC
Nominal voltage	24	V DC
Max. input current	5,2	A
Nominal speed	11500	min <sup>-1</sup>
Motor rating	115	W
Speed control range	1000 - 12000	min <sup>-1</sup>
Internal resistance at desired speed	70	Ω
Permissible ambient temperature	-10 ... +40	°C
Relative humidity	max. 95	%

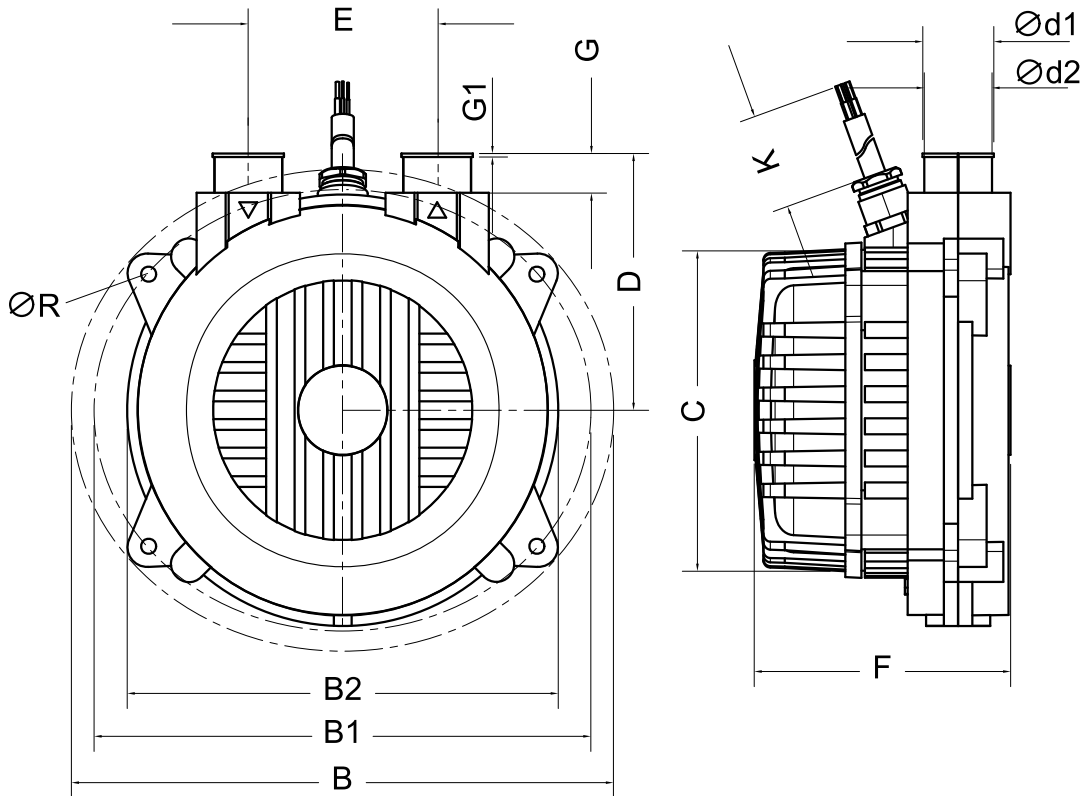
### G\_100 with external electronics / Drivecontrol VT-D

<b>Typ 2BH10 02- _AA53</b>		
<b>Quantity</b>	<b>Value</b>	<b>Unit</b>
Voltage range	38...52	V DC
Nominal voltage	48	V DC
Max. input current	7	A
Nominal speed	15000	min <sup>-1</sup>
Motor rating	300	W
Speed control range	1000 - 15000	min <sup>-1</sup>
Internal resistance at desired speed	70	Ω
Permissible ambient temperature	-10 ... +40	°C
Relative humidity	max. 95	%

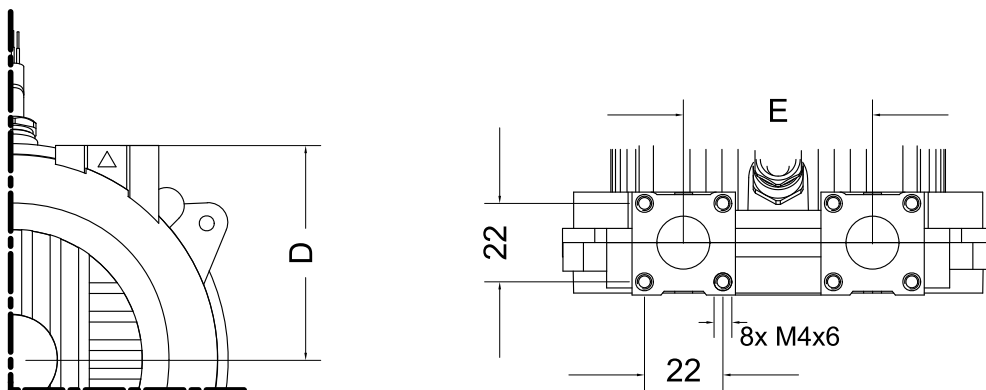
Due to the PWM control of the electronics the power supply unit is loaded with short, high current pulses. For this reason the supply voltage must be blocked or filtered by means of a capacitor (low ESR type, suitable type for high frequencies, high current switching, > 1000 µF) for noise suppression. Usually this capacitor is part of the power supply unit. Switch-mode power supplies, however, are often provided with a capacitor of only very small capacitance at the output so that this kind of pulses result in interference. In this case an additional capacitor must be connected as close to the motor as possible.



**Fig. 1: Dimensions of the 2BH1002-0.... (hose connection)**

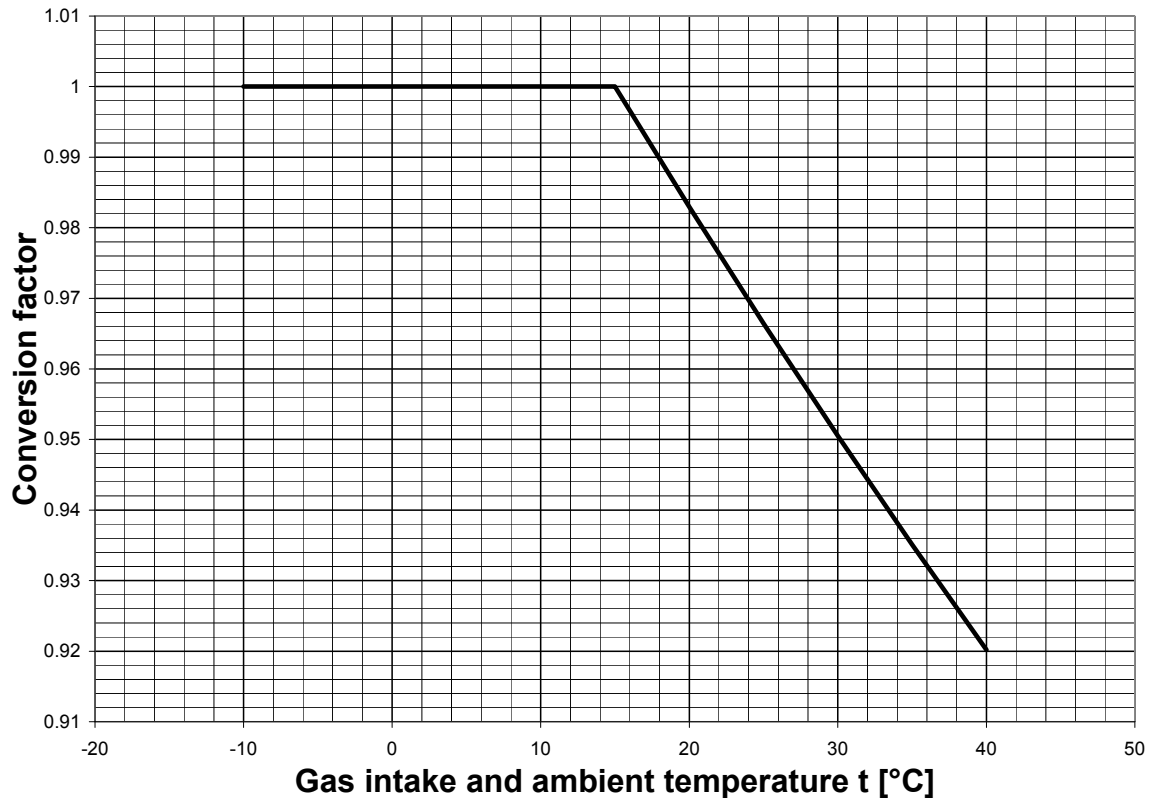


**Fig. 2: Dimensions of the 2BH1002-1.... (flange connection)**



Hose connection	<b>B</b>	<b>B<sub>1</sub></b>	<b>B<sub>2</sub></b>	<b>C</b>	<b>D</b>	$\varnothing d_1$	$\varnothing d_2$	<b>E</b>	<b>F</b>	<b>G</b>	<b>G<sub>1</sub></b>	<b>K</b>	$\varnothing R_2$
2BH1002-0AB32	145	133	121	95	72	20	19	53	72	11	1	450	4,2
2BH1002-0AB22	145	133	121	95	72	20	19	53	72	11	1	450	4,2
2BH1002-0AA53	145	133	121	95	72	20	19	53	92	11	1	450	4,2
Flange connection													
2BH1002-1AB32	145	133	121	95	60	20	19	53	72	11	1	450	4,2
2BH1002-1AB22	145	133	121	95	60	20	19	53	72	11	1	450	4,2
2BH1002-1AA53	145	133	121	95	60	20	19	53	92	11	1	450	4,2

**Fig. 3: Permissible total differential pressure / conversion factor**



For the permissible total differential pressure at an intake and ambient temperature of +15°C see the table in section 4.1, "Nominal and Limiting Values Pump", p. 7.

In order to calculate the permissible total differential pressure for other intake and ambient temperatures proceed as follows:

- Find out your **system-dependent gas intake and ambient temperature**.
- Establish the **conversion factor** valid for these conditions by means of the above diagram. (In order to do so mark your intake and ambient air temperature on the temperature axis. Draw a vertical line from this value to the point of intersection with the curve. Now draw a vertical line from the point of intersection to the conversion-factor axis where you can read the conversion factor then.)
- **Multiply** the established conversion factor with the max. permissible total differential pressure at 15°C as given in the table in section 4.1, "Nominal and Limiting Values Pump", p. 7.
- The result will be a pressure value. This is the **max. permissible total differential pressure** valid for your G\_100 at your system-dependent intake and ambient temperature.

## 5 Transport and Handling

### Packaging:

On delivery the G\_100 is packed up in a cardboard box. When there is no connector attached to the electrical connecting cable the lead ends are surrounded by an ESD-prevention bag.



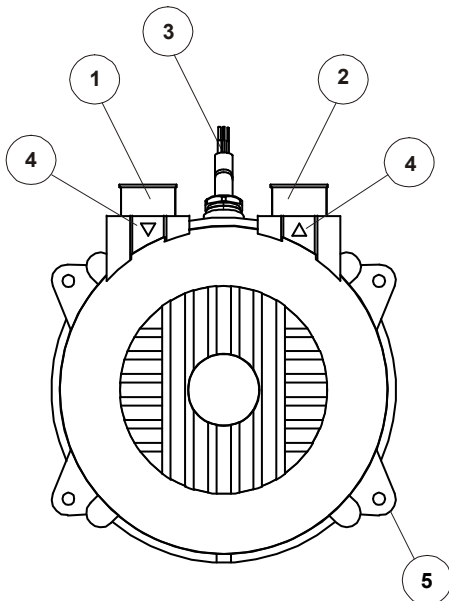
### IMPORTANT!

The motor of the G\_100 including its connecting leads must be protected against electrostatic discharge (ESD). Do not remove the ESD-prevention bag surrounding the lead ends until right before carrying out the electrical connection (attaching the connector, connecting to a terminal strip, or the like)!

## 6 Installation and Commissioning

### 6.1 Mounting

Fig. 4: General view G\_100



#### General view G\_100 (pump side)

- 1 Suction branch
- 2 Delivery branch
- 3 Electrical connecting cable
- 4 Arrows indicating delivery direction
- 5 Fixing lugs for fastening to a mounting surface

For the arrangement of the G\_100 and its components see

- Fig. 4: General view G\_100.

For the space required and the arrangement of the mounting holes required for fastening the G\_100 to the mounting surface please refer to

- Fig. 1: Dimensions of the , p. 9/10

The G\_100 must be mounted as follows:

- the shaft being in any position,
- such as not to exceed the vibration values given in section 4, "Technical Data",
- for heat dissipation and cooling provide a **minimum distance of 15 mm** on each side except for the pump lid side on which a smaller distance of **at least 2 mm** is permissible (in case of mounting using rubber / metal elements, see p. 13).




### CAUTION!

Choose the place of installation / the mounting surface of the G\_100 so that there is no hazard of tripping or bumping!





### IMPORTANT!

Do not install the G\_100 close to heating surfaces! No direct insulation!

	<p><b>CAUTION!</b> Lay the electrical connecting cable so that it might not be damaged by outer influences and is free from tensile stress!</p>

**Sound and vibration attenuation:**





- In order to reduce sound emission fasten the G\_100 only to parts or components **that do not conduct or emit sound easily** (e.g. thin walls, plates).
- Provide **sound-absorbing shims**, termed **rubber / metal elements** (available as accessories). These are rubber pads placed between the four fixing lugs and the mounting surface and used to absorb vibrations.

	<p><b>IMPORTANT!</b> During operation the surface of the G_100 might have high temperatures of more than 100°C! Temperature-sensitive parts or components, e.g. electrical wires or cables or electronic components must not be in contact with or fastened to these surfaces!</p>
	<p><b>CAUTION!</b> Burning and scalding hazard due to hot surfaces of the G_100 during operation! Provide a guard against accidental contact.</p>

Place the rubber / metal elements (rubber pads) between the fixing lugs (Fig. 4, # 6) and the mounting surface.  
Fasten the G\_100 to the mounting surface via the fixing lugs using four suitable bolts or nuts. Property class of the bolts or nuts: 8.8 according to ISO 898.  
Secure the four fixing bolts against unintentional loosening due to vibrations.

## 6.2 Connection

### 6.2.1 Electrical Connection (Motor)

	<p><b>WARNING!</b> Work on electrical installations may be carried out by trained and authorised electricians only!</p>
	<p><b>WARNING!</b> Before beginning any electrical work on the G_100 or the system carry out the following steps for both the G_100 and the entire system</p> <ul style="list-style-type: none"> <li>- switch off electricity,</li> <li>- lock against restart,</li> <li>- ensure absence of electricity,</li> <li>- ground and short-circuit installation,</li> <li>- cover or bar adjacent live parts,</li> </ul>
	<p><b>WARNING!</b> The connecting terminals</p> <ul style="list-style-type: none"> <li>- must be installed such that they cannot be touched during operation!</li> <li>- must be surrounded by a housing which is proof against foreign bodies, humidity, etc.! Consider the life expectancy of the seals and gaskets!</li> <li>- must be separated by sufficient distances (mind protruding wire ends)!</li> </ul>
	<p><b>WARNING!</b> Ensure that no foreign bodies, humidity, etc. enter the motor interior!</p>

The G\_100 is operated using an electronics for speed and direction of rotation control.

Depending on where this electronics is located (inside or outside the G\_100), two types of the G\_100 are distinguished:

- **for external electronics** (see section 6.2.1.1):
  - 2BH10 02-0AA53
- **with integrated electronics** (see section 6.2.1.2):
  - 2BH10 00-0AB32
  - 2BH10 02-0AB22

In order to determine the type of your G\_100 refer to the type number (MLFB) on the rating plate.

**IMPORTANT!**

The motor of the G\_100 including its connecting leads must be protected against electrostatic discharge (ESD).  
Do not remove the ESD-prevention bag surrounding the lead ends until right before carrying out the electrical connection (attaching the connector, connecting to a terminal strip, or the like)!  
Carry out the electrical connection using the appropriate ESD-prevention equipment!

### 6.2.1.1 G\_100 for external electronics

With this type the electronics is located outside the G\_100. It is connected via the electrical connecting cable.

**IMPORTANT!**

The **main or operating direction of rotation** of the G\_100 is the **counter-clockwise rotation**, given by the arrow indicating the direction of rotation on the pump lid (see p. 12, Fig. 4, # 5).  
Only with the counter-clockwise rotation the nominal values will be achieved.

Clockwise rotation is only permissible in special cases.  
In this instance the G\_100 will not achieve its full output.

**IMPORTANT!**

The connecting cable between the G\_100 and the external electronics must have a length of **at maximum 0.5 m!**

**IMPORTANT!**

When switching off the G\_100 or rapidly reducing its speed a current feed into the mains might occur.  
This can be prevented by inserting a diode (Schottky diode, size 10 A) in the 48-V supply lead (+V<sub>CC</sub>).

**IMPORTANT!**

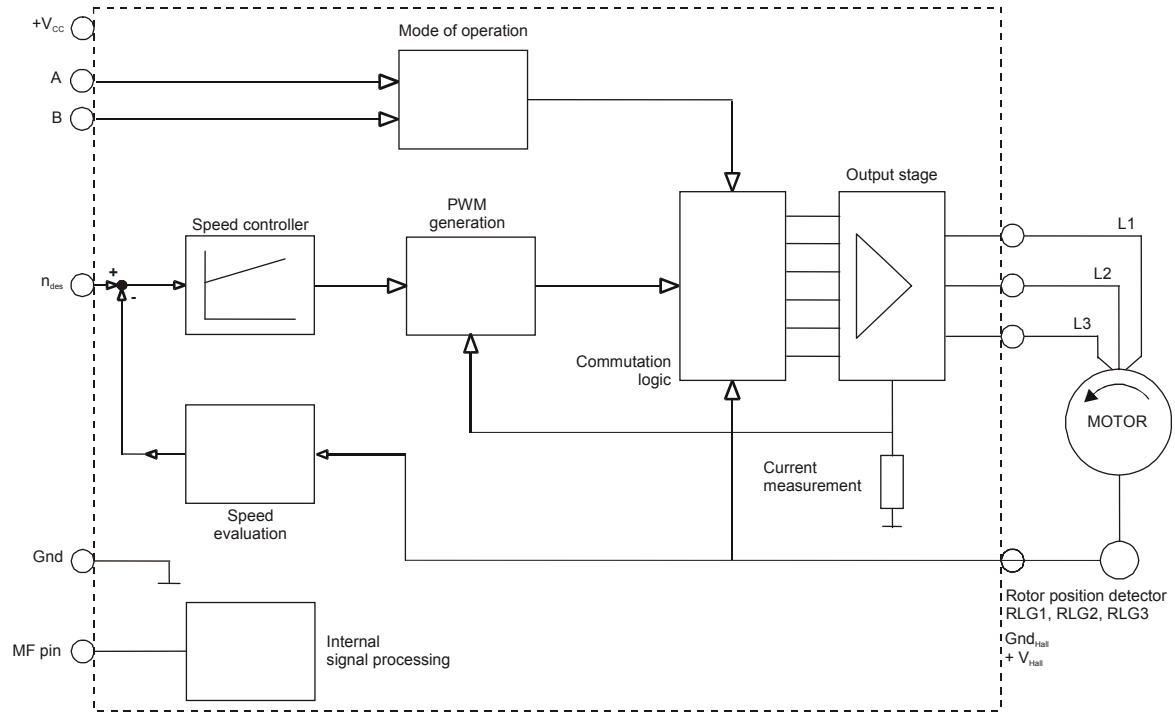
Provide good cooling of the surroundings of the motor and the external electronics (e.g. mounting on a good thermal conductor, sufficient ventilation)!  
In case of temperatures of > 50°C, measured at the surface of the external electronics (Drivecontrol), the output power of the pump might be reduced.

**Purchasing the external electronics (Drivecontrol) along with the G\_100**

For the order no. of this option please refer to our catalogue.

The design of the external electronics (Drivecontrol) is as follows:

**Fig. 5: External electronics: block diagram of the control principle**



**Supply voltage / control signal connection (X3)**

**Motor connection (X4)**

**External electronics**  
Block diagram of the control principle

----- external electronics  
(commercial component)

**Colours of the connecting leads of the motor:**

L1	brown	RLG1	green	Gnd <sub>Hall</sub>	black
L2	violet	RLG2	white	+V <sub>Hall</sub>	red
L3	yellow	RLG3	grey		



**Supply voltage / control signal connection side:**

The connector for supply voltage / control signal connection (connector X3) is shown in Fig. 7.

On the supply voltage / control signal connection side the assignment is as follows:

Symbol	Description		Lead colour	Pin
A	Mode of operation	States: 1 (High): 5 ... max. 30 V 0 (Low): < 0,5 V	white	Pin 1
+U <sub>B</sub>	+ Operating voltage	38 ... 52 V	red	Pin 2
-	Not used		violet	Pin 3
n <sub>Soll</sub> (S <sub>+</sub> )	Speed reference value	Control voltage: 0 ... 10 V Reference value of the desired speed of the G_100.	green	Pin 4
B	Mode of operation	States: 1 (High): 5 ... max. 30 V 0 (Low): < 0,5 V	grey	Pin 5
IST	Actual speed (optional)	Open Collector output Here the rotor speed can be read	yellow	Pin 6
Gnd	- Betriebsspannung	0 V	black	Pin 7
S <sub>-</sub>	Ground Set Value input	0 V	brown	Pin 8

Via the digital control inputs A and B the direction/mode of operation is determined.

The following states are possible:

Level A	Level B	Mode of operation
0	0	Output stage disabled (no current).
0	1	Counter-clockwise rotation (according to the arrow indicating the direction of rotation on the pump lid, see p. 12, Fig. 4, # 5): <b>Main / operating direction of rotation of the G_100!</b>
1	0	Clockwise rotation (opposed to the arrow indicating the direction of rotation on the pump lid, see p. 12, Fig. 4, # 5):
1	1	Breaking

Please take also note of the following data:

Wire cross section of the connecting cable 0.5 mm<sup>2</sup>

Control current on the supply voltage /  
control signal connection side max. 9 A

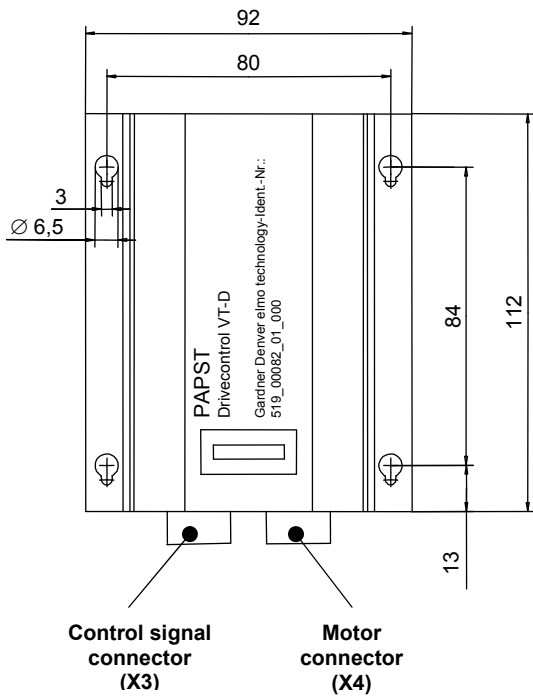
**Motor connection side:**

The connector for motor connection (connector X4) is shown in Fig. 7.

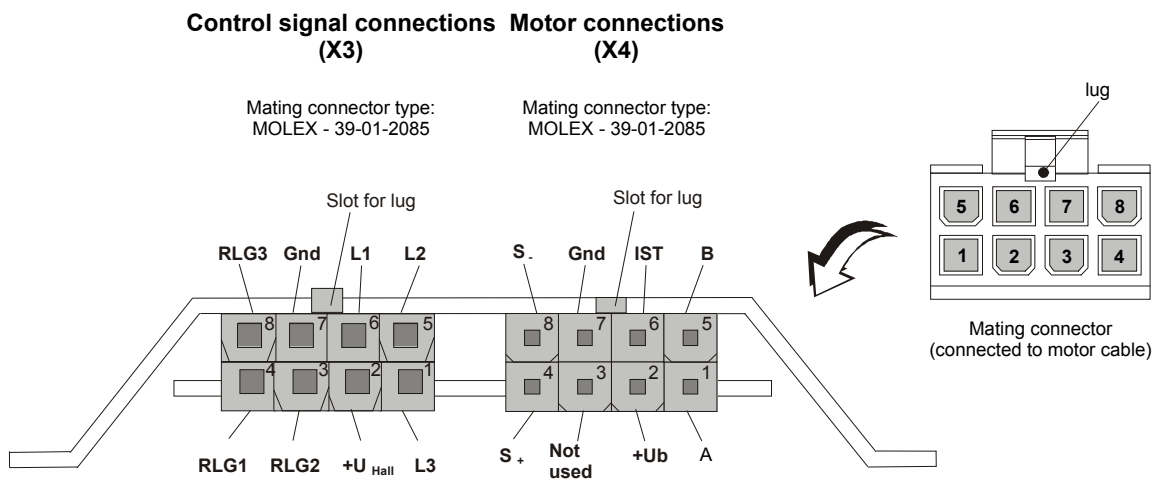
On the motor connection side the assignment is as follows:

Symbol	Description		Lead colour	Pin
L1	Motor phase 1	Terminals of the motor windings. Operating voltage: 0,9 * U <sub>v</sub> max. winding peak current: 13 A max. winding temperature: 115°C	brown	Pin 6
L2	Motor phase 2		violett	Pin 5
L3	Motor phase 3		yellow	Pin 1
RPD1	Hall signal 1	Rotor position detectors. Hall ICs with open collector output. They must be wired to an external pull-up resistor.	green	Pin 4
RPD2	Hall signal 2		white	Pin 3
RPD3	Hall signal 3		grey	Pin 8
+V <sub>Hall</sub>	Hall supply	Feeder line of the hall ICs.	red	Pin 2
Gnd <sub>Hall</sub>	Hall supply		black	Pin 7

**Fig. 6: External electronics**



**Fig. 7: Connector pin assignment and mating connector**



If there is no connector (mating connector to the external electronics) connected to the motor cable of the G\_100, the loose lead ends are surrounded by an ESD-prevention bag. In this case, the socket connector must first be connected to the motor cable.

**IMPORTANT!**

The motor of the G\_100 including its connecting leads must be protected against electrostatic discharge (ESD).

Do not remove the ESD-prevention bag surrounding the lead ends until right before carrying out the electrical connection (attaching the connector, connecting to a terminal strip, or the like)!


Carry out the electrical connection using the appropriate ESD-prevention equipment!

The scope of supply of the external electronics (Drivecontrol VT-D) includes a connector with a 300 mm wiring harness to connect the Drivecontrol to the supply voltage and control voltage.

In order to meet the requirements bearing on **electromagnetic compatibility** a suitable EMI filter (e.g. CORCOM, Type 6ET1, 10A) must be connected in series with the external-electronics. The connecting cable between the EMI filter and the G\_100 must have a length of **at maximum 0,3 m..**

**6.2.1.2 G\_100 with integrated electronics**

With this type the electronics is located inside the motor.

	<p><b>IMPORTANT!</b>                  With the integrated-electronics type G_100 the electronics is particularly sensitive to overheating!                  It is imperative to ensure sufficient heat dissipation and cooling!</p>
---	---

On delivery the integrated-electronics type G\_100 is not equipped with a connector at the connecting cable. In this instance the operator can, according to the requirements of the system, connect a connector at his option, connect the terminals to a terminal strip, etc.

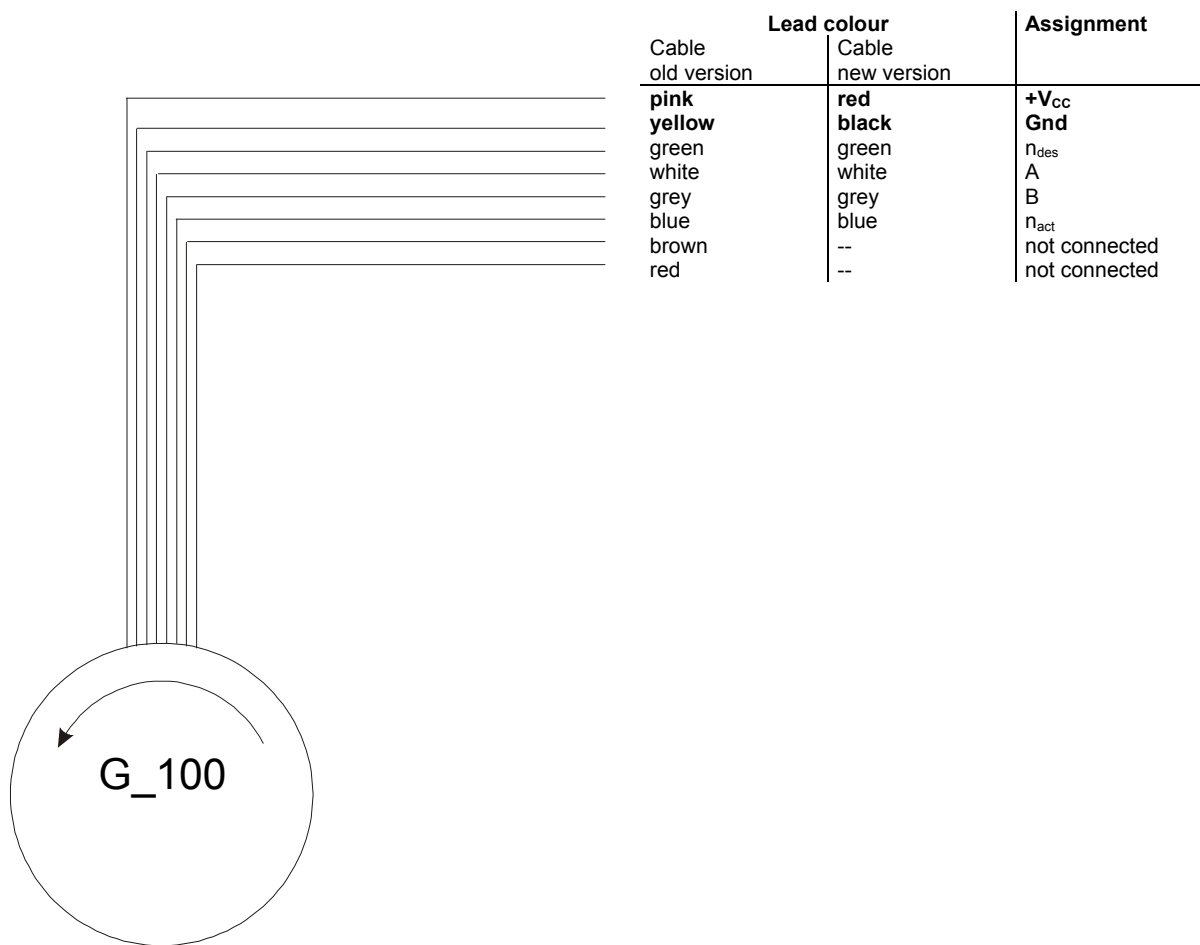
The electrical connection is to be carried out:

- according to the applicable national and local laws and prescriptions
- according to the applicable system-dependent prescriptions and requirements
- according to the applicable prescriptions of the utility company

Via the motor connecting cable the supply voltage as well as the different control signals are applied to the integrated electronics.




For the assignment of the leads or strands please refer to Fig. 8 as well as the following table.

**Fig. 8: Connection of the integrated electronics type**



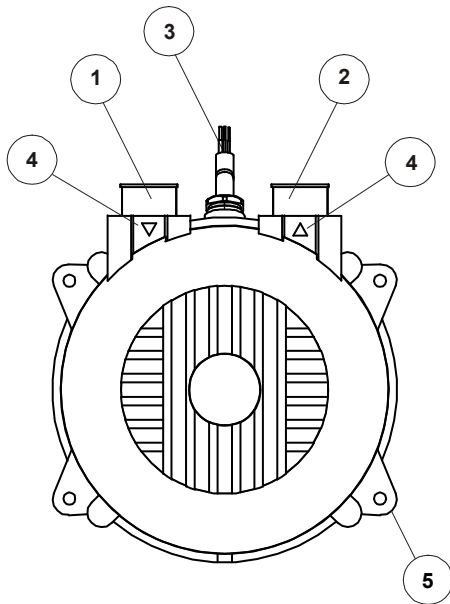
Symbol	Description	Level	Lead colour	
			Cable old version	Cable new version
<b>+V<sub>CC</sub></b>	DC operating voltage	24 V (max. 28 V)	<b>pink</b>	<b>red</b>
<b>Gnd</b>	DC operating voltage, reference potential for all signals	0 V	<b>yellow</b>	<b>black</b>
$n_{des}$	Speed reference value: Reference value of the desired speed of the ELMO® G 2BH10.	0 ... 10 V DC	green	green
$n_{act}$	Frequency output representing the actual speed: open collector signal which must be wired to an external pull-up resistor. Output frequency / motor speed ratio: 1 Hz = 10 min <sup>-1</sup>	Open collector max. 24 V / 10 mA	blue	blue
A	Control signals A and B are digital inputs. Broad voltage-range input compatible with TTL / PLC signals. In all four possible combinations:  <b>A B Function</b> 0 0 Motor disabled (no current) 0 1 CCW rotation 1 0 CW rotation 1 1 Motor disabled	Low (0): < 0.5 V DC High (1): > 4 V DC	white	white
B			grey	grey
--	not connected	--	brown	--
--	not connected	--	red	--

In order to meet the requirements bearing on **electromagnetic compatibility** an EMI filter from Messrs CORCOM, Type 6ETI F7003, 6A, must be connected in series with the integrated-electronics type G\_100. The connecting cable between the EMI filter and the G\_100 must have a length of **at maximum 0.5 m**.

	<p><b>IMPORTANT!</b> The <b>main or operating direction of rotation</b> of the G_100 is the <b>counter-clockwise rotation</b>, given by the arrow indicating the direction of rotation on the pump lid (see p. 12, Fig. 4, # 5). Only with the counter-clockwise rotation the nominal values will be achieved.</p> <p>Clockwise rotation is only permissible in special cases. In this instance the G_100 will not achieve its full output.</p>
	<p><b>IMPORTANT!</b> The connecting cable between the G_100 and the external electronics must have a length of <b>at maximum 0.5 m!</b></p>
	<p><b>IMPORTANT!</b> When switching off the G_100 or rapidly reducing its speed a current feed into the mains might occur. This can be prevented by inserting a diode (Schottky diode, size 6A) in the 24-V supply lead (+V<sub>CC</sub>).</p>

6.2.2 Pipe / hose connections (pump)

**Fig. 9: General view G\_100**



**General view G\_100 (pump side)**

- 6 Suction branch
- 7 Delivery branch
- 8 Electrical connecting cable
- 9 Arrows indicating delivery direction
- 10 Fixing lugs for fastening to a mounting surface

On delivery the suction and delivery branches of the G\_100 are sealed up in order to prevent foreign bodies from entering the pump. Do not remove the seals until right before connecting the pipes / hoses.

	<p><b>IMPORTANT!</b> The G_100 must not be operated with the suction or delivery branches sealed up or jammed!</p>
--	--

For the arrangement of the branches see Fig. 9, "General view".

The operating direction of the G\_100 is indicated by means of arrows:

- The direction of rotation is indicated by an arrow on the pump casing.
- The delivery direction is indicated by arrows on the suction and delivery branches.

	<p><b>IMPORTANT!</b> The <b>main or operating direction of rotation</b> of the G_100 is the <b>counter-clockwise rotation</b>, given by the arrow indicating the direction of rotation on the pump lid (see Fig. 9, # 5). Only with the counter-clockwise rotation the nominal values will be achieved.  Clockwise rotation is only permissible in special cases. In this instance the G_100 will not achieve its full output.</p>
--	--

The pumped gases / vapours are taken in via the suction branch and are expelled via the delivery branch.





The **suction branch** (Fig. 9, # 1) is indicated by an arrow pointing into the pump. Connect the suction pipe to this branch.

The **delivery branch** (Fig. 9, # 2) is indicated by an arrow pointing out of the pump. Connect the delivery pipe to this branch.





	<p><b>IMPORTANT!</b> These instructions apply to the counter-clockwise rotation! In case of clockwise rotation the suction and delivery branches are exchanged!</p>
--	---

Make sure to connect the pipes / hoses so that the G\_100 will not be subject to any stress or strain.

	<p><b>WARNING!</b> Rotating impeller - hazard of severing limbs!  In case of operation with open suction or delivery branches (drawing-in of gases from or discharge of gases into the surroundings) a piece of pipe or hose <b>with a length of at least 120 mm</b> must <b>by all means</b> be connected to the branch in question in order to prevent the impeller from being reached by fingers!</p>
--	--

	<p><b>IMPORTANT!</b>                  The pipes / hoses must be attached in a secure and tight fashion.                  They must be locked against unintentional loosening e.g. due to vibrations, thermal expansion, etc.</p>
	<p><b>WARNING!</b>                  Check pipes / hoses and vessels for sufficient strength!</p>
	<p><b>WARNING!</b>                  Check pipe / hose connections for tightness!</p>
	<p><b>IMPORTANT!</b>                  Provide a shut-off device and / or a means for depressurisation in both the suction and the delivery pipes.</p>

### 6.3 Commissioning





	<p><b>WARNING!</b> Operation of the G_100 only:</p> <ul style="list-style-type: none"> <li>- with the pump lid assembled</li> <li>- with the pipes / hoses connected to the suction and delivery branches or</li> <li>- in case of operation with open suction or delivery branches (drawing-in of gases from or discharge of gases into the surroundings) with a piece of pipe or hose <b>having a length of at least 120 mm</b> connected to the branch in question</li> <li>- with bearing end housing</li> </ul>
	<p><b>WARNING!</b> Do not reach into the G_100 through open suction or delivery branches! Do not insert any objects into the G_100 through the openings!</p>
	<p><b>IMPORTANT!</b> The G_100 must not be operated with the suction or delivery branches sealed up or jammed!</p>
	<p><b>WARNING!</b> Before start-up</p> <ul style="list-style-type: none"> <li>- check pipes / hoses and vessels for sufficient strength!</li> <li>- check pipe / hose connections for tightness!</li> <li>- check fasteners for secure fixing</li> </ul>

Proceed as follows:

- Make sure
  - that the suction and delivery pipes are correctly connected,
  - that in case of operation with open suction or delivery branches (drawing-in of gases from or discharge of gases into the surroundings)  
a piece of pipe or hose **having a length of at least 120 mm** is connected to the branch in question in order to prevent the impeller from being reached by fingers.
  - that the suction and delivery pipes are not jammed,
  - that all fasteners are properly tightened,
  - that the correct voltage and current are applied.
- Set the control voltage serving as speed reference and applied to  $n_{des}$  to 0 V at first.
- Turn on the indicated operating voltage.  
Now increase the control voltage serving as speed reference and applied to  $n_{des}$  (0 to 10 V) to your desired value or the value given on the data sheet.  
By means of this speed control the operating point of the G\_100 is adapted to the operating point of the system.
- Check the connections for tightness (ensure that there is no fluid leakage).



## 7 Operation








	<p><b>WARNING!</b> Operation of the G_100 only:</p> <ul style="list-style-type: none"> <li>- with the pump lid assembled</li> <li>- with the pipes / hoses connected to the suction and delivery branches or</li> <li>- in case of operation with open suction or delivery branches (drawing-in of gases from or discharge of gases into the surroundings) with a piece of pipe or hose <b>having a length of at least 120 mm</b> connected to the branch in question</li> <li>- with the bearing end housing</li> </ul>
	<p><b>IMPORTANT!</b> The G_100 must not be operated with the suction or delivery branches sealed up or jammed!</p>
	<p><b>CAUTION!</b> Burning and scalding hazard due to hot surfaces of the G_100! Do not touch during operation!</p>
	<p><b>WARNING!</b> Before start-up and at regular intervals</p> <ul style="list-style-type: none"> <li>- check pipes / hoses and vessels for sufficient strength!</li> <li>- check pipe / hose connections for tightness!</li> <li>- check fasteners for secure fixing</li> </ul>

### Speed control:

During operation the speed of the G\_100 can be modified. This allows to adapt the operating point of the G\_100 to changes in the operating point of the system.

In order to do so adjust the control voltage applied to  $n_{des}$  within a range of 0 to 10 V.

## 8 Servicing

	<p><b>WARNING!</b></p> <p>Before beginning to work on the G_100 or the system carry out the following steps for both the G_100 and the entire system</p> <ul style="list-style-type: none"> <li>- switch off electricity,</li> <li>- lock against restart,</li> <li>- ensure absence of electricity,</li> <li>- ground and short-circuit installation,</li> <li>- cover or bar adjacent live parts,</li> <li>- depressurise both pipes and pump.</li> </ul>
	<p><b>WARNING!</b></p> <p>Disassembly of</p> <ul style="list-style-type: none"> <li>- the pump lid</li> <li>- the pipe / hose connections</li> <li>- the guard in front of the motor</li> </ul> <p>only after the impeller and the rotor have come to a complete standstill! Consider run-out!</p> <p>Disassembly of the bearing end housing is prohibited!</p>
	<p><b>CAUTION!</b></p> <p>Burning and scalding hazard due to hot surfaces of the G_100! Let the unit cool after shut-down!</p>
	<p><b>WARNING!</b></p> <p>Do not reach into the G_100 through open suction or delivery branches! Do not insert any objects into the G_100 through the openings!</p>
	<p><b>CAUTION!</b></p> <p>After loosening clampings and fastening elements some parts and components are only held in place by their centring or seatings or are no longer held in place at all so that they might fall down.</p>
	<p><b>WARNING!</b></p> <p>Before recommissioning</p> <ul style="list-style-type: none"> <li>- completely re-assemble the G_100</li> <li>- check if all fasteners have been re-assembled and tightened</li> <li>- check pipes / hoses and vessels for sufficient strength</li> <li>- check pipe / hose connections for tightness</li> </ul>
	<p><b>WARNING!</b></p> <p>Work on electrical installations may be carried out by trained and authorised electricians only!</p>

## 8.1 Maintenance

### 8.1.1 Cleaning

#### Exterior:


In case of lint or dust on the pump:  
Clean the entire surface of the G\_100 wiping it with a wet cloth.


- Remove lint using e.g. a pair of tweezers.

#### Interior:

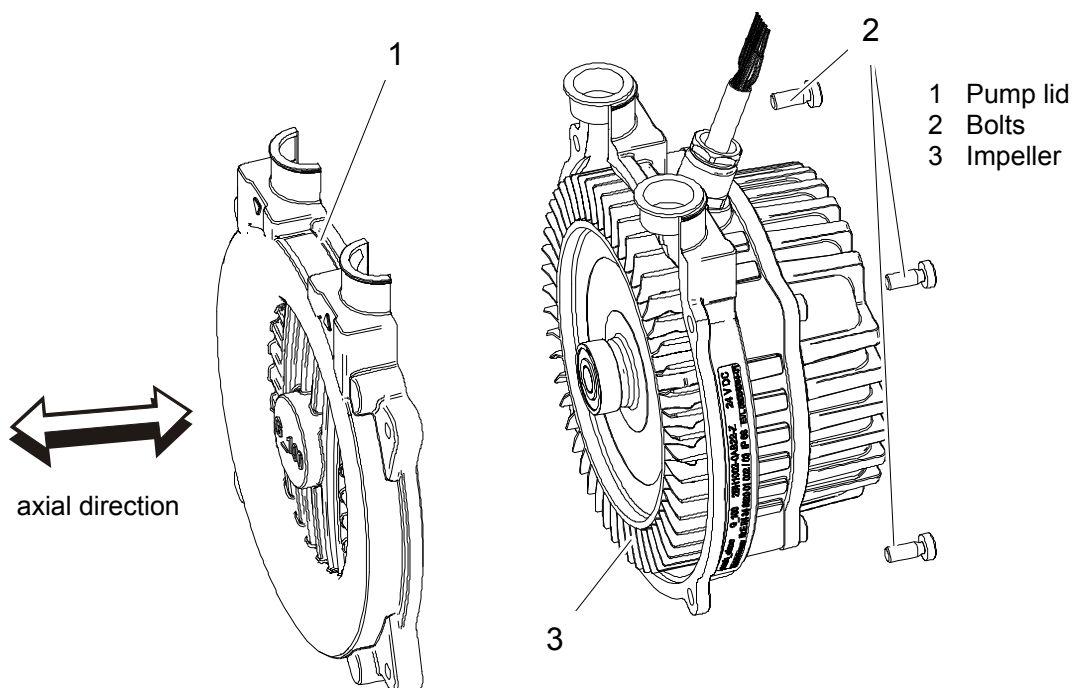
- See also Fig. 10: Disassembly / assembly of the pump lid
- Disassemble pump lid (# 1).  
In order to do so loosen the four bolts (# 2) and carefully pull off the lid in axial direction (see arrow) so that the pin (# 3) is not bent.

- Re-assemble pump lid (# 1).  
In order to do so carefully set the lid to the pump so that the pin (# 3) is inserted in the hole and thus the lid is aligned. Carefully place the lid on the pump in axial direction (see arrow) so that the pin is not bent. Screw in the bolts (# 2) securing them using **Loctite 243**.  
Fastening torque of the bolts:  
 $T_f = 2 \text{ Nm} \pm 0.2$

	<p><b>IMPORTANT!</b> <b>Don not detach the impeller nut (# 4)! Do not disassemble the impeller (# 5)!</b> Otherwise, inside the motor the rotor would be displaced by a spring resulting in the G_100 having to be completely disassembled and re-assembled!</p>
---	--

	<p><b>IMPORTANT!</b> Do not use compressed air in order to clean the pump interior since this might result in dirt entering the motor interior.</p>
---	---

**Fig. 10: Disassembly / assembly of the pump lid**




### 8.1.2 Inspection

Carry out the following tasks on the G\_100 at regular intervals:

- **Fastening to the mounting surface:**  
Tighten fixing bolts.  
Fastening torque: according to property class 8.8 of the bolts or nuts used as given in ISO 898
- **Cable entry:**  
Tighten screwed cable glands.  
Fastening torques:
  - on casing side:  $T_f = 3.2 \text{ Nm} \pm 0.2$
  - on cable side:  $T_f = 1.5 \text{ Nm} \pm 0.2$
- **Suction and delivery branches:**  
Check pipe / hose connections for secure fixing and tightness.  
Check pipes / hoses for tightness.  
Consider material fatigue!  
Replace worn parts.

### 8.1.3 Lubrication


	<p><b>IMPORTANT!</b> The bearings of the G_100 are provided with a lifetime lubrication and assembled in the pump by adhesive bonding. In case the bearing is damaged or grease renewal is due the "complete casing" (i.e. the unit consisting of casing, stator and two ball bearings) must be replaced.</p>
---	---

## 8.2 Repair / Troubleshooting

Fault	Cause	Remedy	Carried out by
Motor does not start, no motor noise.	At least two power supply leads interrupted.	Check fuses, terminals and supply leads and close circuit where interrupted.	Electrician
	No signal at control signal inputs A and B.	Apply control signals, see section 6.2.1, "Electrical Connection (Motor)".	Electrician
	No speed reference value given.	Set speed reference value, see section 6.2.1, "Electrical Connection (Motor)".	Electrician
Motor does not start, humming noise.	Impeller jammed.	Open pump lid, remove dirt and foreign bodies, as described in section 8.1.1, "Cleaning".	Qualified personnel
	Impeller damaged.	Replace impeller.	After-sales service
	Motor bearing damaged.	Replace "complete casing" (i.e. the unit consisting of casing, stator and two ball bearings).	After-sales service
	Wrong connection of motor connecting leads.	Check and, if necessary, correct the connection of the motor phases and hall signals to the drive electronics, see section 6.2.1, "Electrical Connection (Motor)".	Electrician

<b>Fault</b>	<b>Cause</b>	<b>Remedy</b>	<b>Carried out by</b>
Power consumption too high.	Winding short-circuit.	Have winding checked.	Electrician
	Motor overload.	Reduce operating pressure. If necessary, clean filter, silencers, and pipes.	Qualified personnel
	Impeller jammed.	See "Motor does not start, humming noise".	Qualified personnel
No vacuum / pressure or too little vacuum / pressure generated.	Leak in the system.	Seal leak in the system.	Qualified personnel
	Wrong direction of rotation.	Reverse direction of rotation by applying the correct signals to the control signal inputs A and B see section 6.2.1, "Electrical Connection (Motor)".	Electrician
	Speed reference value representing the desired speed ( $n_{des}$ ) too low.	Adjust speed reference value ( $n_{des}$ ) within a range of 0...10 V.	Qualified personnel
	Temperature of the electronics too high.	Provide sufficient heat dissipation and cooling.	Qualified personnel
	Compressor too small.	Use bigger compressor	Operator / qualified personnel
	Density of the pumped gas unequal 1,23 g/m <sup>3</sup> (= density of air at 15°C and 1013 mbar).	Use bigger compressor	Operator / qualified personnel
	Impeller dirty.	Clean impeller; if worn, have impeller replaced.	Qualified personnel / after-sales service
Abnormal screeching noise.	Flow rate too high.	Increase pipe cross section, clean pipe.	Qualified personnel
	Ball bearing damaged.	Replace "complete casing" (i.e. the unit consisting of casing, stator and two ball bearings).	After-sales service
Impeller leak.	Relative pressure between compressor and surroundings too high.	The permissible differential pressure between the pump interior and the surroundings has been exceeded. Make sure that the differential pressure is not exceeded.	Qualified personnel
Current feed to the mains.	Caused by switching off or rapidly reducing the speed of the compressor.	Insert a diode (Schottky diode, size 6A respectively 10A) in the 24V respectively 48V supply lead (+V <sub>CC</sub> ).	Electrician

## 9 Shutting Down and Measures for Prolonged Standstill

	<p><b>IMPORTANT!</b> If the storage period exceeds one year the life expectancy of the bearings might be reduced.</p>
---	---

### Measures after shutdown / before storage:

- Seal up the suction and delivery branches.
- Provide loose lead ends with an ESD-prevention bag.
- Ensure the correct storage conditions (see below).

### Storage conditions:

Ambient temperature	-20°C ... +70°C
Relative humidity	10% ... 95%
Atmospheric pressure	500 hPa ... 1,100 hPa
Vibrations	see section 4, "Technical Data".

### Measures before recommissioning after storage:

- Make sure that there is no oxide layer on the contacts. If necessary, remove oxide layer.
- Make sure that the insulation of the electrical connecting cable has not become porous.

## 10 Manufacturer's Declaration / Declaration of Conformity

**Gardner  
Denver**

### EC Declaration of Conformity

Manufacturer: Gardner Denver Deutschland GmbH  
Postfach 1510  
D-97605 Bad Neustadt / Saale

Product designation: Gas-Ring Vacuum Pumps / Compressors of the 2BH10 series  
models 2BH10 02-\_AB32 2BH10 02-\_AB22 2BH10 02-\_AA53

The designated product complies with the provisions of the following European Directives:

**98/37/EC Directive 98/37/EC of the European Parliament and of the Council of 22 June 1998 on the approximation of the laws of the Member States relating to machinery**

**89/336/EEC Council Directive 89/336/EEC of 3 May 1989 on the approximation of the laws of the Member States relating to electromagnetic compatibility**

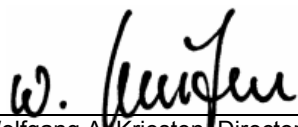
The following harmonised and national standards and specifications have been applied:

Harmonised standards:

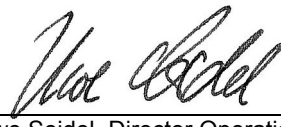
EN ISO 12100-1 2003-11-01	Safety of machinery - Basic concepts, general principles for design; Part 1: Basic terminology, methodology
EN ISO 12100-2 2003-11-01	Safety of machinery - Basic concepts, general principles for design; Part 2: Technical principles
EN 563 1994-06-01	Safety of machinery; Temperatures of touchable surfaces; Ergonomics data to establish temperature limit values for hot surfaces
EN 1012-2 1996-04-01	Compressors and vacuum pumps; Safety requirements; Part 2: Vacuum pumps
EN ISO 3744 1995-09-01	Acoustics - Determination of sound power levels of noise sources using sound pressure
EN 60034-1 2004-06-01	Rotating electrical machines
EN 60204-1 1997-12-01	Safety of machinery; Electrical equipment of machines; Part 1: General requirements (IEC 204-1:1992, modified)
EN 61000-6-2 2005-08-01	Electromagnetic compatibility (EMC); Part 6-2: Generic emission standard: Immunity; Industrial environment
EN 61000-6-3 2001-10-01	Electromagnetic compatibility (EMC) - Part 6-3: Generic standards; Emission standard for residential, commercial and light- industrial environments (IEC 61000-6-3:1996, modified)
EN 61000-63/A11 2004-07-01	Electromagnetic compatibility (EMC) - Part 6-3: Generic standards - Emission standard for residential, commercial and light- industrial environments

Any modifications of the machine that have not beforehand been agreed upon and permitted by us in writing invalidate this Declaration of Conformity.

Gardner Denver Deutschland GmbH  
Bad Neustadt / Saale, 2007-01-30



Wolfgang A. Kriesten, Director Sales



Dr. Uwe Seidel, Director Operations and  
Director Engineering & Development

664.44431.40.000